

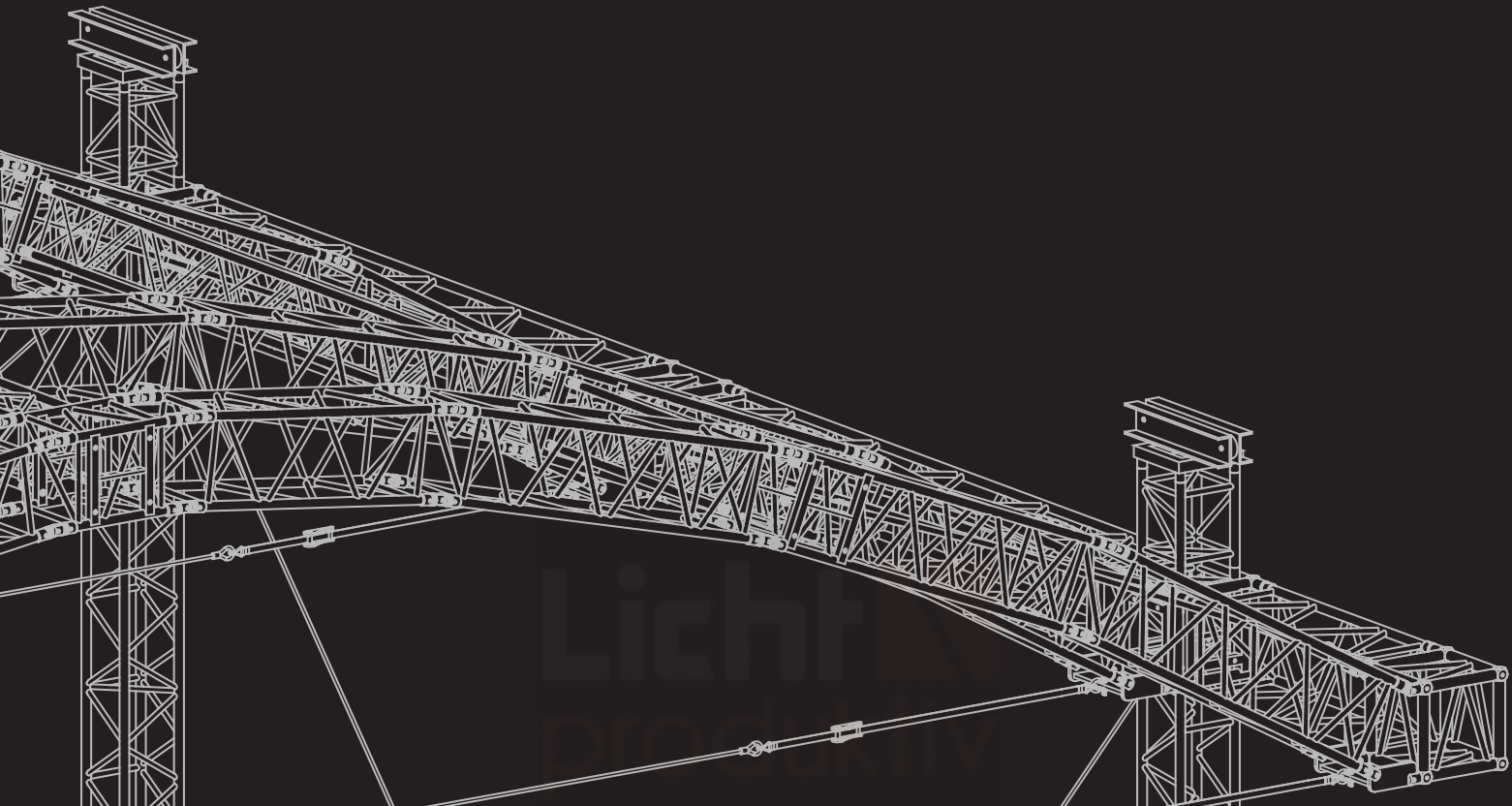

**PROLYTE
STRUCTURES**



**PROLYTE
SYSTEMS**



 **PROLYTE
STRUCTURES**

Trussing
Towers

 **PROLYTE
SYSTEMS**

Rigging Towers
Roof Systems

ProlyteStructures and ProlyteSystems
are Prolyte Group brands

 **PROLYTE
GROUP**



PROLYTE STRUCTURES



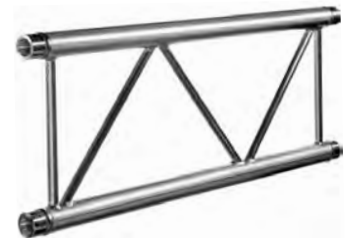
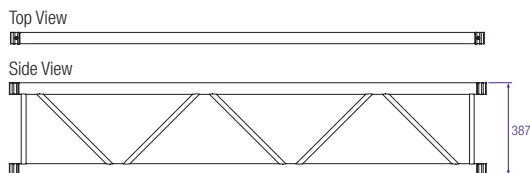

Photo: DWR Distribution CC, South Africa. Project: JHB International Motor Show

H40 Series truss is constructed of main tubes (48,3 x 3 mm) and diagonals (20 x 2 mm), and uses the CCS6 coupling system. ProlyteStructures supplies a variety of H40 Series truss elements that

provide maximum flexibility, including standard or custom-made lengths, circles and arches and several types of corners. ProlyteStructures can create custom-made pieces on request.

H40L



H40D

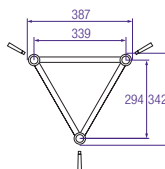
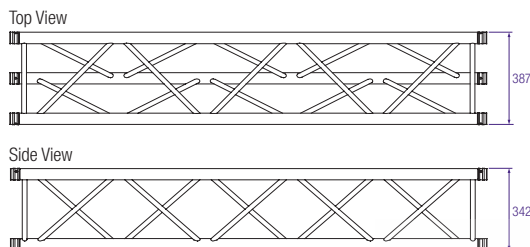

H40V

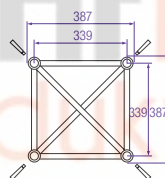
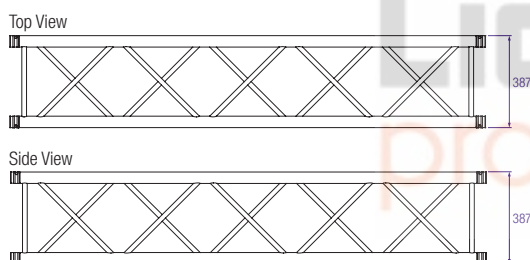

Light
Productiv

H40 SERIES



Photo: IPS, AV Network London Event , H40R truss

H40R

Top View

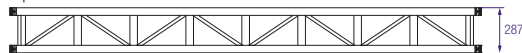

Side View

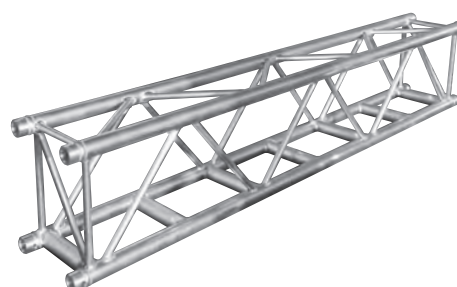
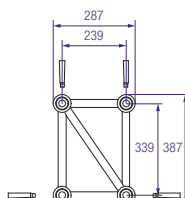

Technical Specifications - H40L, H40D, H40V, H40R

Types	Ladder (L), Triangular (D), Square (V), Rectangular (R)
Alloy	EN AW 6082 T6
Main Tubes (Chords)	48,3 x 3 mm
Braces	20 x 2 mm
Coupling System	CCS6

Structural data can be found at www.prolyte.com

H40L, H40D, H40V - Standard available Lengths and Codes

Metres	Feet	Code*
0.25/1.00 m in 5 mm steps	0.82'/3.28', in 0.2' steps	
0,25	0.82	H40•-L025
0,50	1.90	H40•-L050
0,75	2.46	H40•-L075
0,81	2.65	H40•-L081
1,00	3.28	H40•-L100
1,50	4.57	H40•-L150
2,00	6.56	H40•-L200
2,50	8.20	H40•-L250
3,00	9.84	H40•-L300
3,50	11.48	H40•-L350
4,00	13.12	H40•-L400
4,50	14.76	H40•-L450
5,00	16.40	H40•-L500

*on • indicate L for Ladder, D for triangular or V for Square truss. Example: H40V-L200

Licht
produktiv



H40D - Allowable Loading

SPAN		Uniformly Distributed Load		DEFLECTION		MAXIMUM ALLOWABLE POINT LOADS										SPAN
						Centre Point Load		DEFLECTION		Single Load Third Points Load per Point		Single Load Fourth Points Load per Point		Single Load Fifth Points Load per Point		
m	ft	kg/m	lbs/ft	mm	inch	CPL		DEFLECTION		TPL		QPL		FPL		total weight
3	9,8	724,4	487,4	9	0,4	1048,3	2313,5	8	0,3	715,6	1579,4	581,4	1283,2	451,7	996,8	15,0
4	13,1	487,6	328,1	17	0,7	824,1	1818,9	13	0,5	573,8	1266,3	446,7	985,8	352,4	777,8	20,0
5	16,4	310,4	208,9	26	1,0	677,3	1494,8	21	0,8	477,8	1054,6	361,7	798,2	288,3	636,3	25,0
6	19,7	214,2	144,1	38	1,5	573,4	1265,4	30	1,2	408,5	901,5	303,0	668,8	243,3	536,9	30,0
7	23,0	156,2	105,1	51	2,0	495,7	1094,1	41	1,6	355,9	785,4	260,0	573,8	209,9	463,2	35,0
8	26,2	118,5	79,8	64	2,5	435,3	960,7	53	2,1	314,5	694,1	226,9	500,9	184,0	406,0	40,0
9	29,5	92,7	62,4	85	3,3	386,8	853,8	68	2,7	281,0	620,2	200,7	443,0	163,3	360,4	45,0
10	32,8	74,2	50,0	104	4,1	347,0	765,8	84	3,3	253,3	558,9	179,3	395,8	146,3	323,0	50,0
11	36,1	60,6	40,8	126	5,0	313,5	691,9	101	4,0	229,8	507,3	161,5	356,5	132,1	291,6	55,0
12	39,4	50,2	33,8	150	5,9	284,9	628,9	120	4,7	209,8	463,0	146,4	323,1	120,1	265,0	60,0
13	42,6	42,1	28,3	176	6,9	260,2	574,3	141	5,6	192,3	424,5	133,4	294,3	109,6	241,9	65,0
14	45,9	35,7	24,0	205	8,1	238,5	526,4	164	6,5	177,0	390,6	122,0	269,2	100,5	221,7	70,0
15	49,2	30,5	20,5	235	9,3	219,3	484,0	188	7,4	163,3	360,5	111,9	247,1	92,4	203,9	75,0
16	52,5	26,3	17,7	267	10,5	202,1	446,0	214	8,4	151,1	333,5	103,0	227,3	85,1	187,9	80,0
17	55,8	22,7	15,3	302	11,9	186,6	411,7	241	9,5	140,0	309,0	94,9	209,5	78,6	173,5	85,0
18	59,0	19,8	13,3	338	13,3	172,4	380,6	271	10,7	129,9	286,8	87,6	193,4	72,7	160,5	90,0
19	62,3	17,3	11,6	377	14,8	159,5	352,1	302	11,9	120,7	266,3	81,0	178,7	67,3	148,5	95,0
20	65,6	15,2	10,2	417	16,4	147,6	325,8	334	13,1	112,1	247,5	74,9	165,2	62,3	137,5	100,0

1 inch = 25,4 mm | 1 m = 3,28 ft | 1 lbs = 0,453 kg

- Tüv certification only valid for loading table above.
- Loading figures are only valid for static loads.
- Loading figures are only valid for single spans with supports at both ends.
- All static systems, other than single spans, need an individual structural calculation. Please contact a structural engineer or Prolyte Group for assistance.
- Loading figures are calculated according to and in full compliance with European standards (Eurocode).
- The self-weight of the trusses is already taken into account.
- Loading figures are only valid for the cross sectional orientation of the truss as shown by the icon in the loading table.
- The interaction between bending moment and shear force at the connection point is already taken into account.
- Truss spans can be assembled from different truss lengths.
- Read the manual before assembling, using and loading the truss.



H40 SERIES

H40V - Allowable Loading

SPAN		Uniformly Distributed Load		DEFLECTION		MAXIMUM ALLOWABLE POINT LOADS										SPAN
		UDL	UDL			Centre Point Load		DEFLECTION		Single Load Third Points Load per Point		Single Load Fourth Points Load per Point		Single Load Fifth Points Load per Point		
m	ft			kg/m	lbs/ft	mm	inch	CPL		TPL		QPL		FPL		total weight
						kgs	lbs	mm	inch	kgs	lbs	kgs	lbs	kgs	lbs	
3	9,8	835,4	562,1	7	0,3	2198,9	4853,1	6	0,2	1253,2	2765,8	835,4	1843,8	626,6	1382,9	20,7
4	13,1	625,0	420,6	13	0,5	1712,4	3779,2	10	0,4	1215,1	2681,7	833,4	1839,3	625,0	1379,5	27,6
5	16,4	498,8	335,6	20	0,8	1435,8	3168,9	16	0,6	994,0	2193,8	815,2	1799,1	623,5	1376,0	34,5
6	19,7	414,6	279,0	29	1,1	1234,4	2724,4	23	0,9	851,7	1879,7	676,0	1492,0	529,7	1169,0	41,4
7	23,0	354,5	238,5	40	1,6	1080,9	2385,6	32	1,2	753,5	1663,0	585,0	1291,2	462,0	1019,6	48,3
8	26,2	277,5	186,7	52	2,0	959,8	2118,3	41	1,6	674,7	1489,0	514,7	1136,0	409,1	902,8	55,2
9	29,5	218,0	146,7	65	2,6	861,7	1901,7	52	2,1	609,9	1346,1	458,7	1012,3	366,4	808,7	62,1
10	32,8	175,4	118,0	81	3,2	780,4	1722,3	65	2,5	555,7	1226,4	412,9	911,3	331,2	731,0	69,0
11	36,1	143,9	96,8	98	3,8	711,8	1570,9	78	3,1	509,5	1124,6	374,7	827,0	301,7	665,8	75,9
12	39,4	119,9	80,7	116	4,6	653,1	1441,4	93	3,7	469,7	1036,7	342,3	755,5	276,5	610,2	82,8
13	42,6	101,2	68,1	137	5,4	602,2	1328,9	109	4,3	435,0	960,0	314,4	693,9	254,7	562,1	89,7
14	45,9	86,4	58,2	158	6,2	557,5	1230,3	127	5,0	404,3	892,3	290,1	640,3	235,6	519,9	96,6
15	49,2	74,5	50,1	182	7,2	517,9	1143,0	146	5,7	377,0	832,1	268,8	593,1	218,7	482,7	103,5
16	52,5	64,7	43,5	207	8,1	482,5	1064,9	166	6,5	352,5	778,0	249,8	551,2	203,7	449,6	110,4
17	55,8	56,6	38,1	234	9,2	450,7	994,7	187	7,4	330,4	729,2	232,7	513,7	190,2	419,7	117,3
18	59,0	49,8	33,5	262	10,3	421,8	931,0	210	8,3	310,3	684,8	217,4	479,7	178,0	392,8	124,2
19	62,3	44,1	29,7	292	11,5	395,5	872,8	233	9,2	291,9	644,1	203,4	448,9	166,8	368,2	131,1
20	65,6	39,2	26,4	323	12,7	371,3	819,5	259	10,2	274,9	606,7	190,7	420,8	156,6	345,7	138,0

1 inch = 25,4 mm | 1m = 3.28 ft | 1 lbs = 0,453 kg

- Tuv certification only valid for loading table above.
- Loading figures are only valid for static loads.
- Loading figures are only valid for single spans with supports at both ends.
- All static systems, other than single spans, need an individual structural calculation. Please contact a structural engineer or Prolyte Group for assistance.
- Loading figures are calculated according to and in full compliance with European standards (Eurocode).
- The self-weight of the trusses is already taken into account.
- Loading figures are only valid for the cross sectional orientation of the truss as shown by the icon in the loading table.
- The interaction between bending moment and shear force at the connection point is already taken into account.
- Truss spans can be assembled from different truss lengths.
- Read the manual before assembling, using and loading the truss.





H40R - Allowable Loading

SPAN		Uniformly Distributed Load		DEFLECTION		MAXIMUM ALLOWABLE POINT LOADS										SPAN
						Centre Point Load		Single Load Third Points Load per Point		Single Load Fourth Points Load per Point		Single Load Fifth Points Load per Point				
		UDL				CPL		DEFLECTION		TPL		QPL		FPL		total weight
m	ft	kg/m	lbs/ft	mm	inch	kgs	lbs	mm	inch	kgs	lbs	kgs	lbs	kgs	lbs	
3	9,8	835,3	562,0	7	0,3	2198,8	4852,8	6	0,2	1252,9	2765,2	835,3	1843,4	626,5	1382,6	20,7
4	13,1	624,9	420,4	13	0,5	1712,1	3778,7	10	0,4	1214,9	2681,3	833,1	1838,7	624,9	1379,1	27,6
5	16,4	498,6	335,5	20	0,8	1435,5	3168,2	16	0,6	993,8	2193,4	815,0	1798,7	623,3	1375,5	34,5
6	19,7	414,4	278,9	29	1,1	1234,1	2723,6	23	0,9	851,5	1879,2	675,8	1491,5	529,5	1168,7	41,4
7	23,0	354,3	238,4	40	1,6	1080,5	2384,6	32	1,2	753,2	1662,4	584,8	1290,6	461,8	1019,1	48,3
8	26,2	277,3	186,6	52	2,0	959,3	2117,1	41	1,6	674,4	1488,3	514,4	1135,3	408,8	902,3	55,2
9	29,5	217,8	146,5	65	2,6	861,0	1900,3	52	2,1	609,5	1345,3	458,3	1011,6	366,1	808,1	62,1
10	32,8	175,2	117,9	81	3,2	779,7	1720,7	65	2,5	555,3	1225,4	412,5	910,4	330,9	730,4	69,0
11	36,1	143,7	96,7	98	3,8	711,0	1569,2	78	3,1	509,0	1123,4	374,3	826,0	301,3	665,1	75,9
12	39,4	119,7	80,5	116	4,6	652,2	1439,4	93	3,7	469,2	1035,4	341,8	754,4	276,1	609,3	82,8
13	42,6	101,1	68,0	137	5,4	601,2	1326,8	109	4,3	434,3	958,6	313,9	692,7	254,3	561,1	89,7
14	45,9	86,3	58,0	158	6,2	556,4	1228,0	127	5,0	403,6	890,8	289,6	639,1	235,1	519,0	96,6
15	49,2	74,3	50,0	182	7,2	516,7	1140,4	146	5,7	376,3	830,4	268,1	591,8	218,2	481,7	103,5
16	52,5	64,5	43,4	207	8,1	481,3	1062,2	166	6,5	351,7	776,2	249,1	549,7	203,2	448,4	110,4
17	55,8	56,4	38,0	234	9,2	449,3	991,7	187	7,4	329,5	727,3	232,0	512,1	189,6	418,5	117,3
18	59,0	49,7	33,4	262	10,3	420,4	927,8	210	8,3	309,3	682,7	216,6	478,1	177,4	391,4	124,2
19	62,3	43,9	29,5	292	11,5	394,0	869,5	233	9,2	290,9	641,9	202,6	447,2	166,2	366,8	131,1
20	65,6	39,0	26,2	323	12,7	369,7	816,0	259	10,2	273,9	604,4	189,8	418,9	156,0	344,2	138

1 inch = 25,4 mm | 1m = 3,28 ft | 1 lbs = 0,453 kg

- Tüv certification only valid for loading table above.
- Loading figures are only valid for static loads.
- Loading figures are only valid for single spans with supports at both ends.
- All static systems, other than single spans, need an individual structural calculation. Please contact a structural engineer or Prolyte Group for assistance.
- Loading figures are calculated according to and in full compliance with European standards (Eurocode).
- The self-weight of the trusses is already taken into account.
- Loading figures are only valid for the cross sectional orientation of the truss as shown by the icon in the loading table.
- The interaction between bending moment and shear force at the connection point is already taken into account.
- Truss spans can be assembled from different truss lengths.
- Read the manual before assembling, using and loading the truss.



H40R - Standard available Lengths and Codes

Metres	Feet	Code*
0,25/1.00 m in 5 mm steps	0.82'/3.28', in 0.2' steps	
0,25	0.83	H40R-L025
0,50	1.90	H40R-L050
0,75	2.46	H40R-L075
1,00	3.28	H40R-L100
1,50	4.57	H40R-L150
2,00	6.56	H40R-L200
2,50	8.20	H40R-L250
3,00	9.84	H40R-L300
3,50	11.48	H40R-L350
4,00	13.12	H40R-L400



H40 SERIES

H40L - Allowable Loading (Span supported on top chord.)

SPAN		Uniformly Distributed Load		DEFLECTION		CPL		DEFLECTION	
m	ft	kg/m	lbs/ft	mm	inch	kgs	lbs	mm	inch
1	3,3	1259,8	847,7	1	0,0	1259,8	2780,4	0	0,0
2	6,6	629,0	423,2	1	0,0	629,0	1388,2	1	0,0
3	9,8	253,0	170,2	2	0,1	380,0	838,7	1	0,1
4	13,1	105,0	70,7	2	0,1	210,0	463,5	2	0,1
5	16,4	52,0	35,0	3	0,1	130,0	286,9	2	0,1
6	19,7	24,0	16,1	3	0,1	72,0	158,9	2	0,1

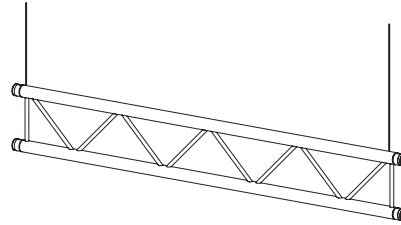

1 inch = 25,4 mm | 1m = 3.28 ft | 1 lbs = 0,453 kg

Spans must be supported at each end.
Loads must be suspended from bottom chord only.

H40L - Allowable Loading (Top chord sideways supported each metre.)

SPAN		Uniformly Distributed Load		DEFLECTION		CPL		DEFLECTION	
m	ft	kg/m	lbs/ft	mm	inch	kgs	lbs	mm	inch
4	13,1	312,9	210,6	13	0,5	806,8	1780,5	10	0,4
5	16,4	249,8	168,1	20	0,8	682,7	1506,7	16	0,6
6	19,7	207,7	139,8	29	1,1	590,9	1304,1	23	0,9
7	23,0	173,4	116,7	40	1,6	520,2	1148,0	32	1,2
8	26,2	133,7	90,0	52	2,0	463,9	1023,7	41	1,6
9	29,5	106,0	71,3	65	2,6	417,9	922,4	52	2,1
10	32,8	85,8	57,7	81	3,2	379,7	838,0	65	2,5
11	36,1	70,8	47,6	98	3,8	347,3	766,5	78	3,1
12	39,4	59,2	39,9	116	4,6	319,5	705,1	93	3,7

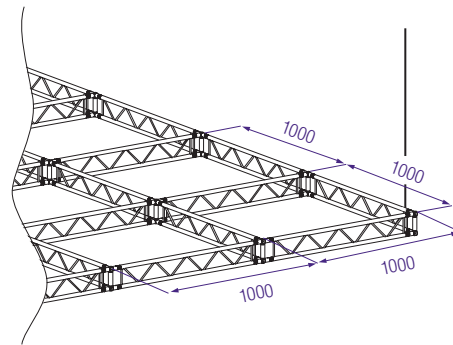

1 inch = 25,4 mm | 1m = 3.28 ft | 1 lbs = 0,453 kg

Spans must be supported at each end.
Loads must be suspended from bottom chord only.

H40L - Allowable Loading (Top chords sideways supported every 2 metres.)

SPAN		Uniformly Distributed Load		DEFLECTION		CPL		DEFLECTION	
m	ft	kg/m	lbs/ft	mm	inch	kgs	lbs	mm	inch
4	13,1	156,2	105,1	4	0,1	312,5	689,6	3	0,1
5	16,4	99,0	66,6	6	0,2	247,5	546,3	5	0,2
6	19,7	67,9	45,7	8	0,3	203,8	449,8	7	0,3
7	23,0	49,2	33,1	11	0,4	172,2	380,0	9	0,3
8	26,2	37,0	24,9	14	0,6	148,1	326,9	12	0,5
9	29,5	28,7	19,3	18	0,7	129,1	285,0	15	0,6
10	32,8	22,7	15,3	23	0,9	113,6	250,8	18	0,7
11	36,1	18,3	12,3	27	1,1	100,7	222,3	22	0,9
12	39,4	15,0	10,1	33	1,3	89,8	198,1	26	1,0

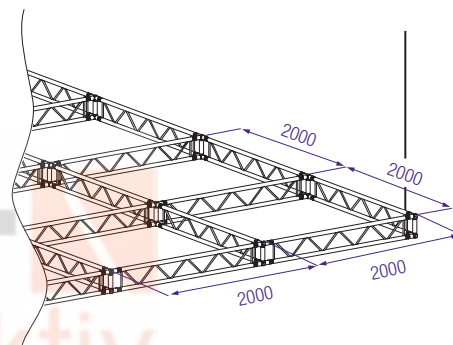

1 inch = 25,4 mm | 1m = 3.28 ft | 1 lbs = 0,453 kg

Spans must be supported at each end.
Loads must be suspended from bottom chord only.

TRIANGULAR CORNERS E20D / A03 / X/H30 / H40D

Triangular Corners

measurements in mm	A	B	C	D	E	F	G	H	K	L
E20D	800	264	415	400	178	272	308	203	578	603
AstraLite3	400	800	600	575	550	575				
X/H30D	1000	300	498	500	210	333	380	242	710	742
H40D	1200	258	525	600	210	376	439	255	810	855

C001 - 45°

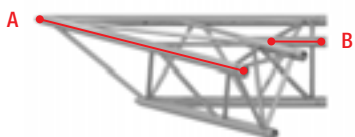

C002 - 60°



C003 - 90°

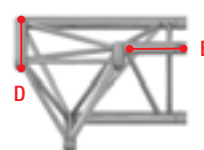

C004 - 120°

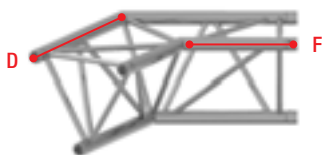

C005 - 135°

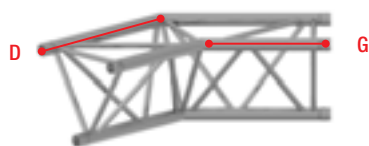

C006

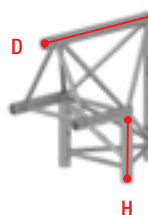

C007

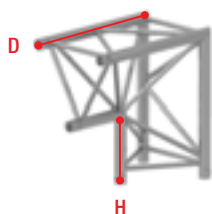

C010

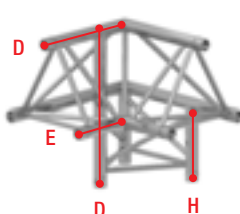

C011

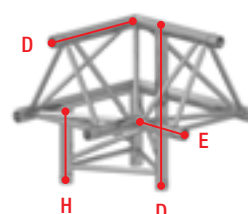

C012

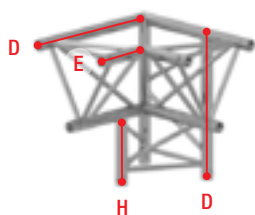

C013

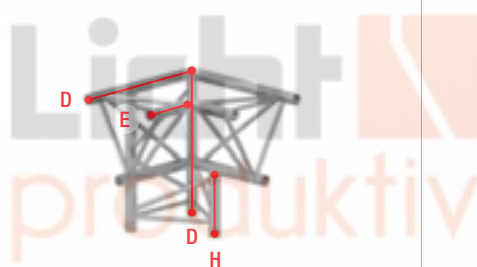

C014

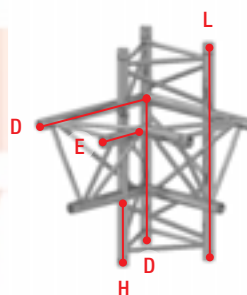



Triangular Corners

measurements in mm	A	B	C	D	E	F	G	H	K	L
E20D	800	264	415	400	178	272	308	203	578	603
AstraLite3	400	800	600	575	550	575				
X/H30D	1000	300	498	500	210	333	380	242	710	742
H40D	1200	258	525	600	210	376	439	255	810	855

C015

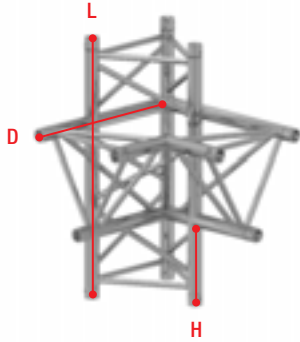

C016

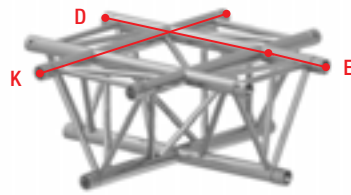

C017

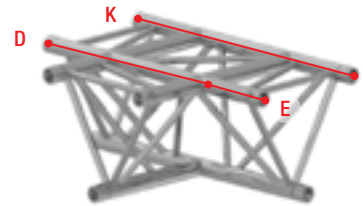

C018

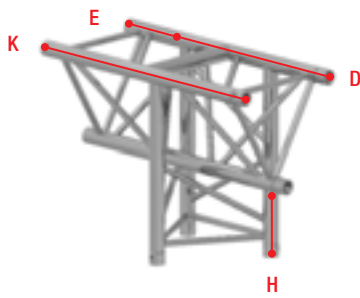

C019

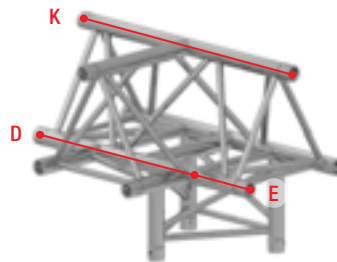

C020

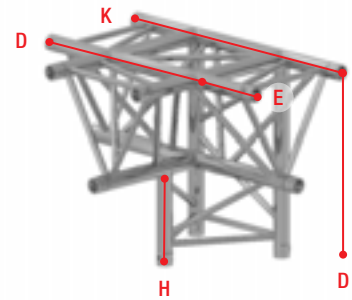

C021

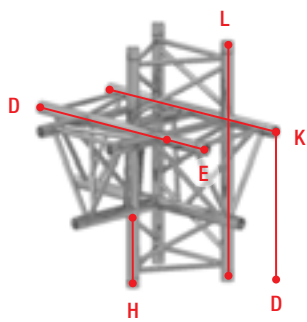

C022

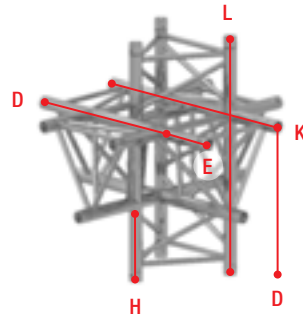

C023

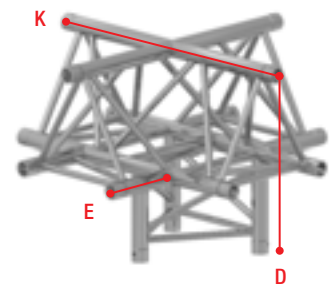

C024

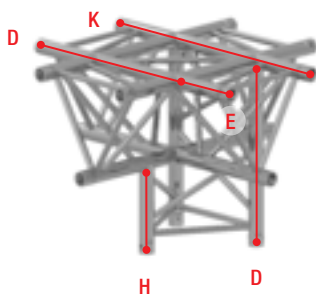

C039

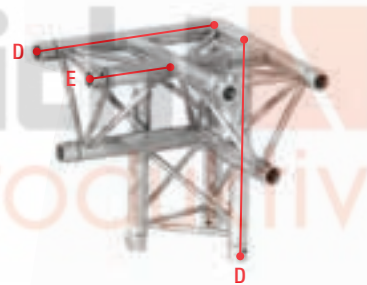

Lit
productiv



Photo: © the Prolyte Group.

PROLYTE STRUCTURES

ProlyteStructures

Truss products are the building blocks of our industry. Prolyte has developed a broad range of trusses and the unique conical coupling system, CCS, suitable for a variety of applications from decorative solutions to intricate truss structures.

ProlyteStructures is capable of meeting all your truss needs, from a simple flown grid or exhibition booth to elaborate or composite structures prepared for high loading.

Safety first

ProlyteStructures encompasses trusses and complementary corners and accessories; all designed and manufactured according to a strict philosophy that emphasizes safety by making high quality products in compliance with the strictest

regulations and standards.

Next to that, simplicity, ease-of-use and configuration flexibility guarantee user-friendly products designed for daily practice.

Prolyte provides comprehensive data and offers expert guidance and training to promote the correct use and safe application of its truss systems.

The choice of professionals

Prolyte manufactures trusses with original, advanced designs based on the experience and feedback of a worldwide community of users. Your ideas and requirements are incorporated into the latest generation products to ensure the highest level of functionality, reliability and safety. User experiences and changing market demands are the source of continuous product improvement and inspiration to design new products. With an installed rental base throughout Europa and further, Prolyte is the choice of professionals.



Photo by Gerard Henninger: Stageco, project: Ziggo Dome, 538 Jingleball

Architectural truss

Architectural truss from Prolyte, encompassing the E series, AstraLite and AstraLite truss, as well as the XU30D and XL30D truss provide the solution for systems integrators, retail installations and structures with a mainly decorative function.

These trusses combine structural components with highly aesthetic looks and the added functionality of a track lighting system.

Multipurpose truss

The multipurpose truss range comprises of the X30, H30 and H40 series, available in ladder, triangular and square profiles. The X30, H30 and H40 series are light-to-medium-duty truss systems designed for use in the installation, rental and exhibition markets. These trusses are strong, compact, exceptionally versatile, and have low self-weight. Assembly is fool proof due to the continuous webbing of the diagonals. The X and H series are differentiated by wall thickness of the main chords; 2 mm. for

the X truss and 3mm. for the H truss. Although almost identical in appearance, H series trusses are up to 30% stronger, specifically on longer spans.

System applications

If you're looking for solutions for permanent or semi permanent installations, architectural set pieces, theatre sets, shop displays, studio grids, or showroom applications, the X series truss is your answer. The exceptional strength in relation to their relatively small dimensions of the X truss makes it the ideal solution for complex structures like displays or booths. The H series trusses are primarily designed for high-frequency users such as rental or exhibition companies, or for semi permanent installations in demanding circumstances like moving lighting rigs in discotheques, stage scenery elements or touring exhibition stands.



**PROLYTE
GROUP**

Helping you build great things

As world leading manufacturer of hardware products and structural solutions for the entertainment industry Prolyte Group is passionate about offering the best solutions for its users and customers. Making the basic building blocks of its industry performances, like trussing, staging and electrical hoists, Prolyte endeavours for product excellence and

continuous product innovation. By actively engaging in raising the level of knowledge and by providing solutions that work in daily practice, Prolyte looks to support the creativity of designers on the one hand and the safety of technicians on the other.

By committing to provide a high level of expertise and professionalism along with a friendly and uncomplicated approach Prolyte offers unrivalled products and services, which is why users and customers choose to work with Prolyte. By prioritising mutual respect and trust, Prolyte creates long-term relations with both its users and customers.



When this is all coming together Prolyte is your first step to start building great things. Prolyte Group is headquartered in Leek, the Netherlands, where the complex process of design, engineering and sales come together. Prolyte has a manufacturing base in Slatina, Romania and a strategically positioned warehouse in Emsdetten, Germany, to provide stock and logistic facilities in the heart of mainland Europe.

Completing the team effort is a network of distribution partners; Prolyte distributes products to over 50 geographical markets worldwide. It utilises its network of partners who not only

supply but also endorse its products with impeccable customer service and outstanding technical support, enforcing Prolyte's reputation as a market leader for quality, safety and customer satisfaction.

You can find Prolyte products in installations, events and productions all over the world.